

Heatsinks for LEDs



- suitable for free or forced convection
- heat sink dimensions are fitted to the respective LED type
- simple mounting by using thermally conductive adhesive foil, glue or screw mounting
- specific versions on customer's request
- double-sided adhesive thermal conductive foil **WLF ...** → E 7
- special design, surfaces and modification to customer specification on request
- **surface:** black anodised

<p>art. no.</p> <p>ICK LED R 23,5 x 14 WLF ... D 23</p>			<p>$R_{th} = 18,58 \text{ K/W}$</p>
<p>art. no.</p> <p>ICK LED R 23,5 x 14 G WLF ... D 23</p>			
<p>art. no.</p> <p>ICK LED R 27 x 10 WLF ... D 27</p>			<p>$R_{th} = 17,69 \text{ K/W}$</p>
<p>art. no.</p> <p>ICK LED R 27 x 10 G WLF ... D 27</p>			
<p>art. no.</p> <p>ICK LED R 28 x 15 WLF ... D 28</p>			<p>$R_{th} = 15,24 \text{ K/W}$</p>

Heatsinks for LEDs

<p>art. no.</p> <p>ICK LED R 28 x 15 G WLF ... D 28</p>		
<p>art. no.</p> <p>ICK LED R 29 x 11,5 WLF ... D 29</p>		<p>$R_{th} = 17,26 \text{ K/W}$</p>
<p>art. no.</p> <p>ICK LED R 29 x 11,5 G WLF ... D 29</p>		
<p>art. no.</p> <p>ICK LED R 32 x 14 WLF ... D 32</p>		<p>$R_{th} = 15,23 \text{ K/W}$</p>
<p>art. no.</p> <p>ICK LED R 32 x 14 G WLF ... D 32</p>		
<p>art. no.</p> <p>ICK LED R 33 x 10 WLF ... D 33</p>		<p>$R_{th} = 17,6 \text{ K/W}$</p>
<p>art. no.</p> <p>ICK LED R 33 x 10 G WLF ... D 33</p>		

Heatsinks for LEDs

<p>art. no.</p> <p>ICK LED R 33 x 16,5 WLF ... D 33</p>			<p>$R_{th} = 13,87 \text{ K/W}$</p>
<p>art. no.</p> <p>ICK LED R 33 x 16,5 G WLF ... D 33</p>			
<p>art. no.</p> <p>ICK LED R 35 x 10 WLF ... D 35</p>			<p>$R_{th} = 16,9 \text{ K/W}$</p>
<p>art. no.</p> <p>ICK LED R 35 x 10 G WLF ... D 35</p>			
<p>art. no.</p> <p>ICK LED R 36 x 12 WLF ... D 36</p>			<p>$R_{th} = 12,88 \text{ K/W}$</p>
<p>art. no.</p> <p>ICK LED R 36 x 12 G WLF ... D 36</p>			
<p>art. no.</p> <p>ICK LED R 40 x 10 WLF ... D 40</p>			<p>$R_{th} = 12,28 \text{ K/W}$</p>

B 37

Pin heatsinks \varnothing
Mounts
Thermally conductive foil
Thermal conductive paste

→ B 29 – 33
→ E 44 – 48
→ E 5 – 15
→ E 21 – 22

Thermal conductive glue
Hole pattern
Heatsink profile-overview
Technical introduction

→ E 23 – 24
→ A 21
→ A 13 – 17
→ A 2 – 8

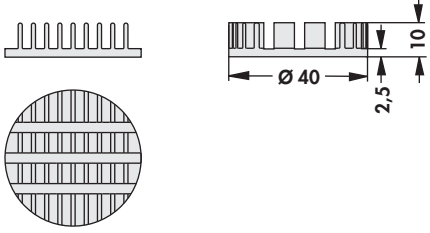
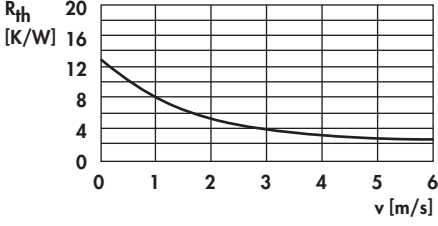
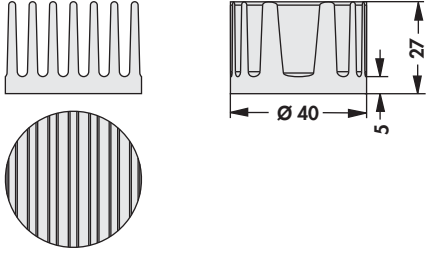
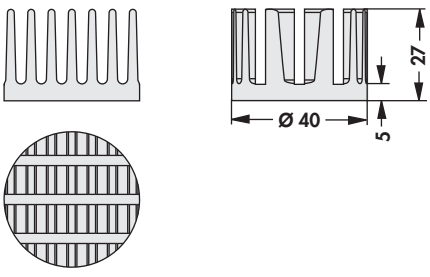
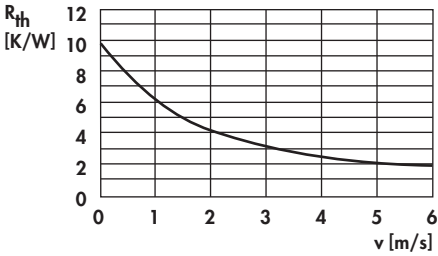
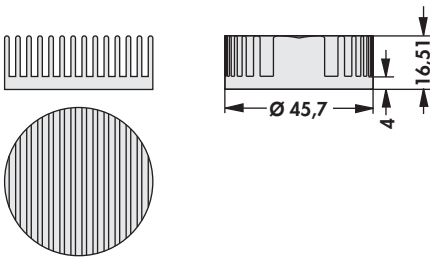
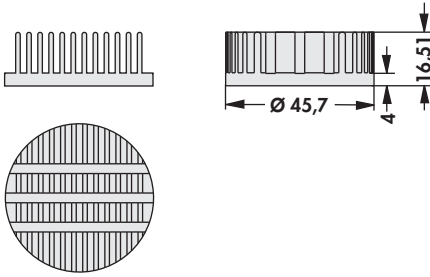
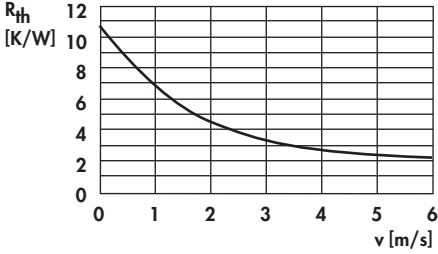
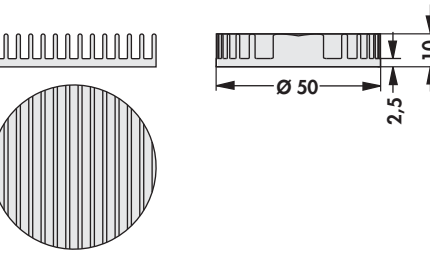
<p>art. no.</p> <p>ICK LED R 40 x 10 G WLF ... D 40</p>		
<p>art. no.</p> <p>ICK LED R 40 x 27 WLF ... D 40</p>		<p>$R_{th} = 9,41 \text{ K/W}$</p>
<p>art. no.</p> <p>ICK LED R 40 x 27 G WLF ... D 40</p>		
<p>art. no.</p> <p>ICK LED R 45,7 x 16,5 WLF ... D 45</p>		<p>$R_{th} = 10,46 \text{ K/W}$</p>
<p>art. no.</p> <p>ICK LED R 45,7 x 16,5 G WLF ... D 45</p>		
<p>art. no.</p> <p>ICK LED R 50 x 10 WLF ... D 50</p>		<p>$R_{th} = 10,57 \text{ K/W}$</p>

Heatsinks for LEDs

<p>art. no.</p> <p>ICK LED R 50 x 10 G WLF ... D 50</p>		
<p>art. no.</p> <p>ICK LED R 50,8 x 16,5 WLF ... D 50</p>		<p>$R_{th} = 10,17 \text{ K/W}$</p>
<p>art. no.</p> <p>ICK LED R 50,8 x 16,5 G WLF ... D 50</p>		
<p>art. no.</p> <p>ICK LED R 54 x 20 WLF ... D 54</p>		<p>$R_{th} = 9,48 \text{ K/W}$</p>
<p>art. no.</p> <p>ICK LED R 54 x 20 G WLF ... D 54</p>		
<p>art. no.</p> <p>ICK LED R 66 x 40 WLF ... D 66</p>		<p>$R_{th} = 3,2 \text{ K/W}$</p>

B 39

Pin heatsinks Ø
Mounts
Thermally conductive foil
Thermal conductive paste

→ B 29 – 33
→ E 44 – 48
→ E 5 – 15
→ E 21 – 22



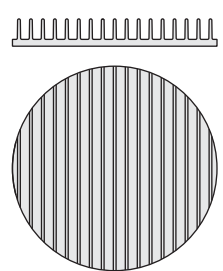
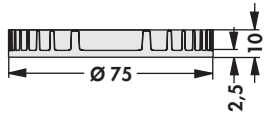
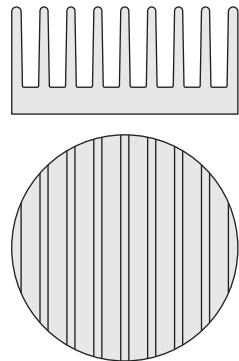
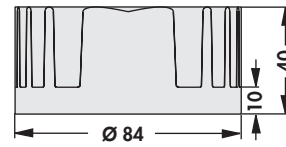
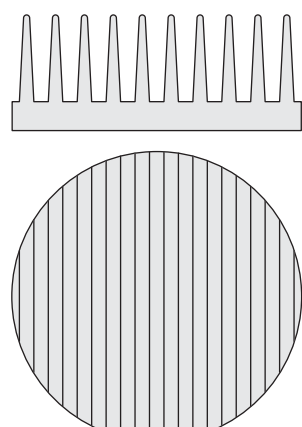
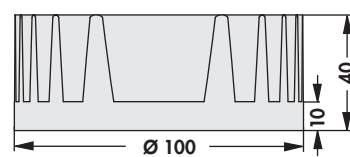
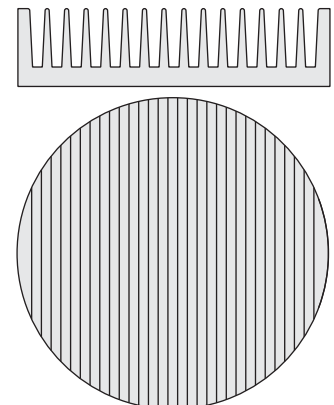
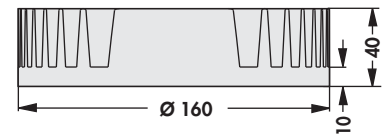

Thermal conductive glue
Hole pattern
Heatsink profile-overview
Technical introduction

→ E 23 – 24
→ A 21
→ A 13 – 17
→ A 2 – 8

<p>art. no.</p> <p>ICK LED R 75 x 10 WLF ... D 75</p>		 <p>$R_{th} = 5,2 \text{ K/W}$</p>
<p>art. no.</p> <p>ICK LED R 84 x 40 WLF ... D 84</p>		 <p>$R_{th} = 2,5 \text{ K/W}$</p>
<p>art. no.</p> <p>ICK LED R 100 x 40 WLF ... D 100</p>		 <p>$R_{th} = 2 \text{ K/W}$</p>
<p>art. no.</p> <p>ICK LED R 160 x 40 WLF ... D 160</p>		 <p>$R_{th} = 1,4 \text{ K/W}$</p>

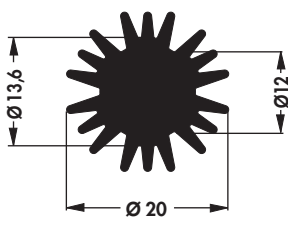
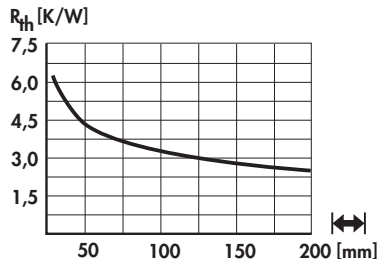
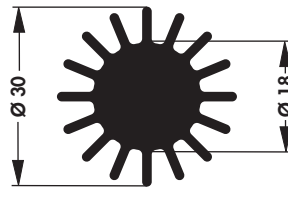
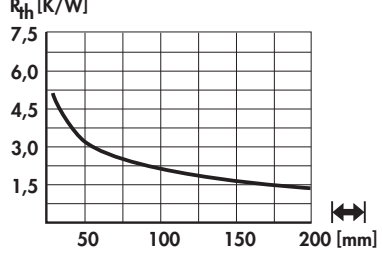
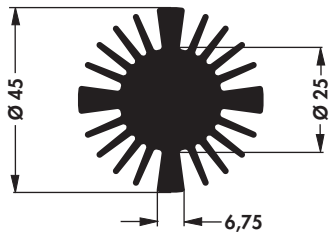
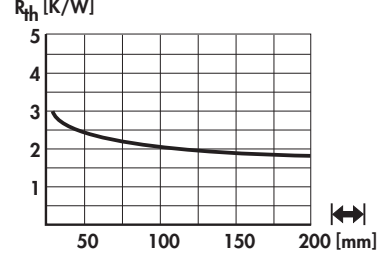
Heatsinks for LEDs

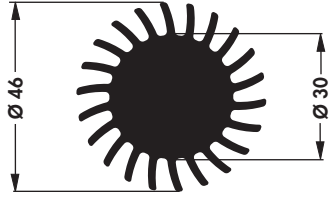
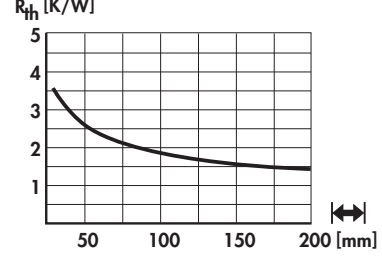
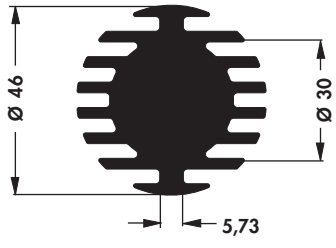
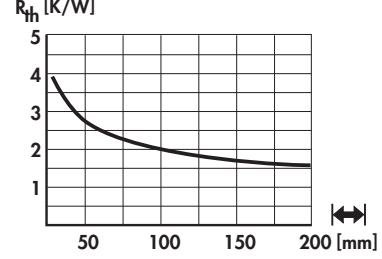
- special design, surfaces and modification to customer specification on request
- up from a profile length of 25 mm: optional adapter plate **LA LED 68 ...** → B 50 suitable for LED modules:
Bridgelux Vero, Citizen CitiLED, Cree XLamp, Edison Edilex, GE Infusion, Luga Shop und Industrial, Lustrous Lustron, Megaman Teco, Osram PrevaLED und Soleriq, Philips Fortimo und Luxeon, Prolight Opto, Sharp Mega Zenigata, Toshiba E-Core, Tridonic Stark, Vexica Lumaera, Vossloh Schwabe

art. no. SK 585 ...		
art. no. SK 620 ...		
art. no. SK 618 ...		
please indicate: ...  10 15 20 25 37.5 50 1000 mm		
surface: black anodised		
art. no. SK 619 ...		
art. no. SK 598 ...		
please indicate: ...  10 15 20 25 37.5 50 1000 mm		
surface: black anodised		
... adapter (optional) AD = adapter plate		







Pin heatsinks Ø
Hole pattern
Special heatsink design
Thermal conductive paste

→ B 29 – 33 Mounts
→ A 21 Thermally conductive foil
→ A 137 – 138 Thermal conductive glue
→ E 21 – 22 Technical introduction

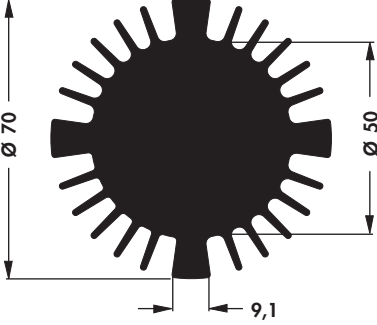
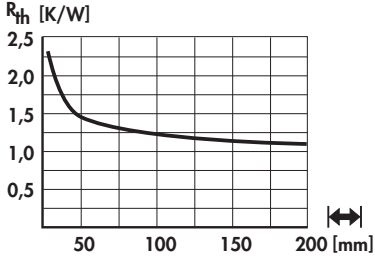
→ E 44 – 48
→ E 5 – 15
→ E 23 – 24
→ A 2 – 8

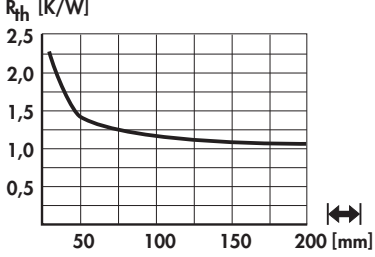
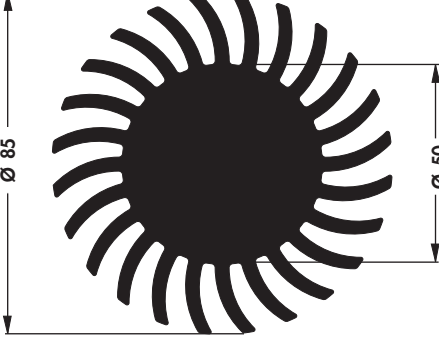
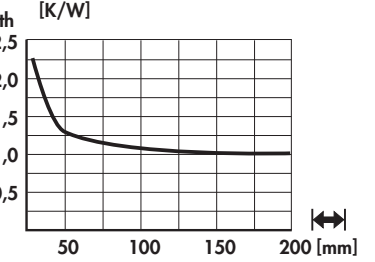

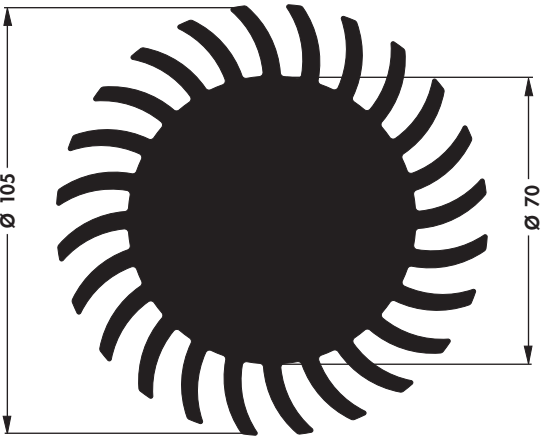
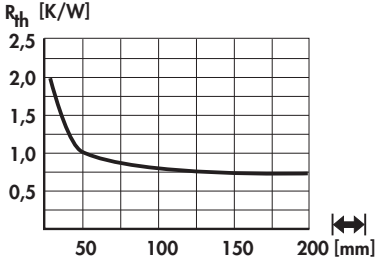
B 42

A
B
C
D
E
F
G
H
I
K
L
M
N

art. no. SK 570 ...		
art. no. SK 571 ...		
art. no. SK 572 ...		
please indicate: ...  10 15 20 25 37.5 50 1000 mm ... adapter (optional) AD = adapter plate		
surface: black anodised		
art. no. SK 584 ...		
please indicate: ...  10 15 20 25 37.5 50 1000 mm		
surface: black anodised		

Heatsinks for LEDs

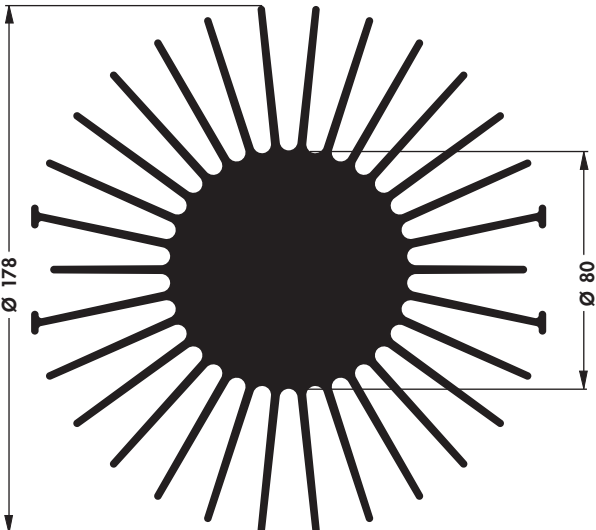
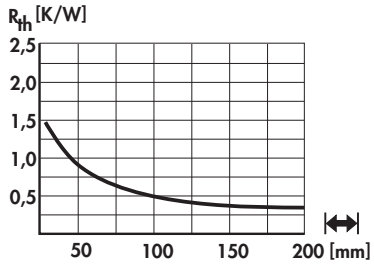
<p>art. no.</p> <p>SK 615 ...</p>		
<p>art. no.</p> <p>SK 599 ...</p>		
<p>art. no.</p> <p>SK 592 ...</p>		
<p>please indicate: ... $\left[\text{mm} \right]$ 10 15 20 25 37.5 50 75 100 150 1000 mm</p>		
<p>surface: black anodised</p>		

art. no.		
SK 590 ...		
please indicate:	...  10 15 20 25 37.5 50 75 100 150 1000 mm	
surface:	black anodised	

LED fin cooler KTE R customised

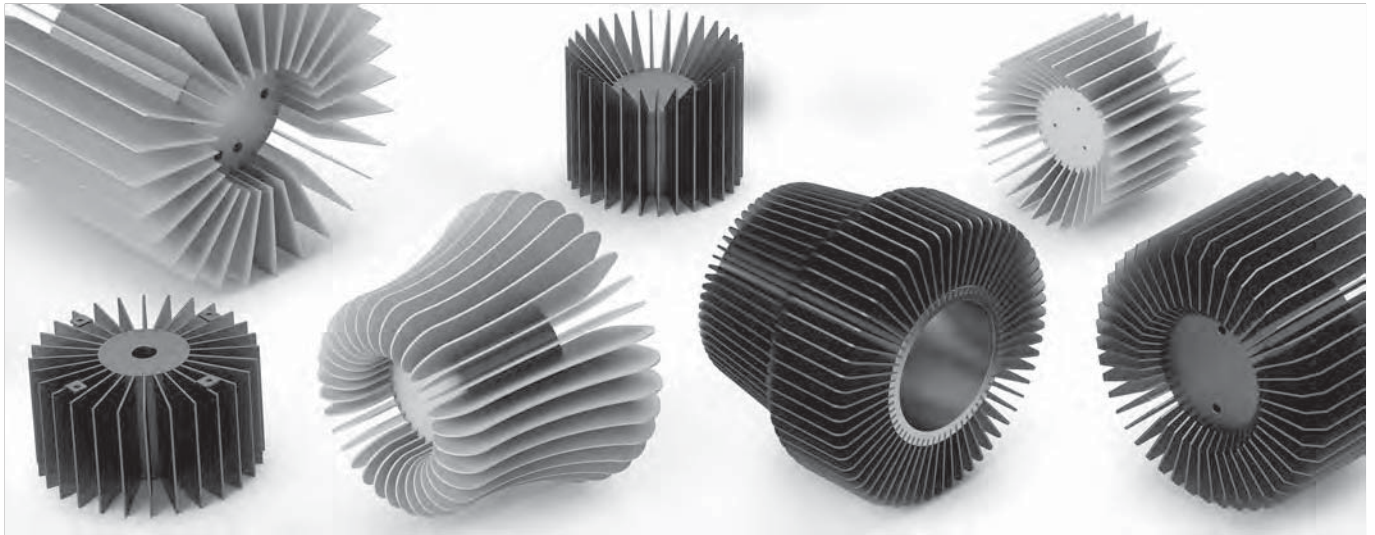

- individual LED heatsinks acc. to customer's requests
- adaptable to all common LED modules and sizes
- integration possibility of reflectors or fans by using special sheet metal design
- entry core for heat dissipation made of copper upon request
- other dimensions, sheet metal geometries, surfaces and mechanical machinings upon request

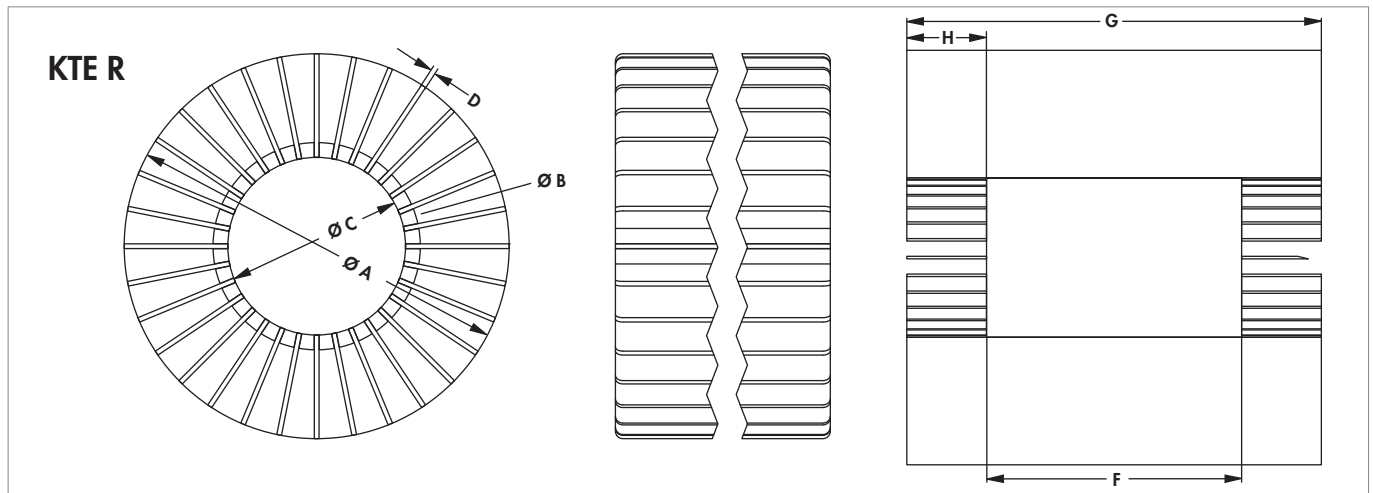

possible dimensions:

dim. [mm]								
A	B	C	D	E	F	G	H	
B + 20 to 200	35	30	0.8	32	max. 400	max. 800	max. 200	
	40	35	1	36				
	55	50	1.5	50				
	80	75	2	72				
	90	85		84				
	100	95		92				

E max. number of grooves at D = 0.8 mm

please indicate with your order:

dim. [mm]								
A	B	C	D	E	F	G	H	

please indicate: ... surface
 SA = black anodised
 ME = clear anodised





material: aluminium

Heatsinks for LEDs

- heatsink specially made for flexible and fixed LED Line Modules
- insertion possibility of metal sheets and sheets of Plexiglas
- customer specified designs, lengths and treatments upon request

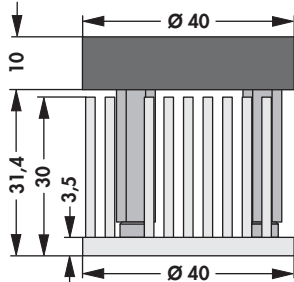
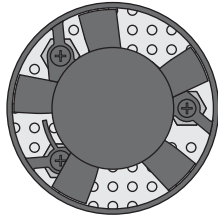
<p>art. no.</p> <p>SK LED 1</p>		
<p>art. no.</p> <p>SK LED 2</p>		
<p>art. no.</p> <p>SK LED 3</p>		
<p>please indicate: ... $\left[\begin{array}{c} \text{---} \\ \text{---} \end{array} \right]$</p> <p>50 75 100 150 1000 mm</p>		<p>... surface</p> <p>SA = black anodised</p> <p>ME = clear anodised</p>

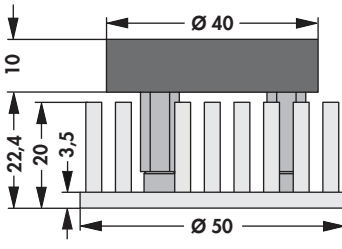
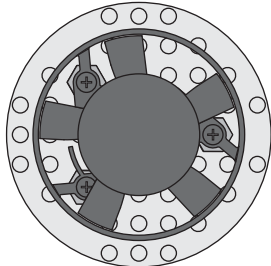
Active heat dissipation of LEDs

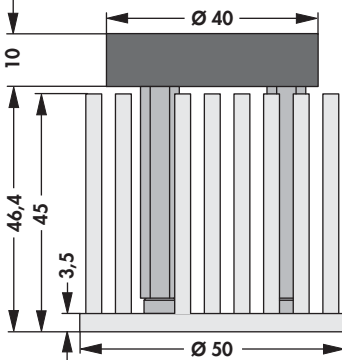
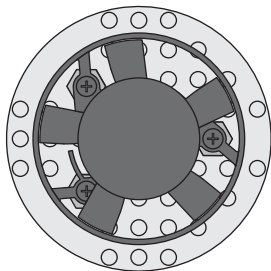
		
art. no. LA LED 40 x 30	R_{th} [K/W] 1.4	
		
art. no. LA LED 50 x 20	R_{th} [K/W] 1.25	
		
art. no. LA LED 50 x 45	R_{th} [K/W] 0.9	

Technical data of the fans

	LF 40B12
circuit voltage	12 V
bearing type	two-way plain bearing
cur. consumpt.	50 mA
max. initial current	160 mA
max. volume flow	157 l/min - 9.4 m ³ /h
max. static pressure	3.4 mmH ₂ O - 33 Pa
noise level	26 dB(A), 1 m lateral
temperature range	-20°C... +60°C
failure rate (L₁₀)	60,000 h
MTBF	1,900,000 h (20°C)
Type rotor speed	6,600 min ⁻¹
weight	10 g



- active heat dissipation of LED modules
- Zhaga compliant mounting possibility
- integrated low noise fan
- optional adapter plate suitable for LED modules:
Bridgelux Vero, Citizen CitiLED, Cree XLamp, Edison Edilex, GE Infusion, Luga Shop und Industrial, Lustrous Lustron, Megaman Teco, Osram PrevaLED und Soleriq, Philips Fortimo und Luxeon, Prolight Opto, Sharp Mega Zenigata, Toshiba E-Core, Tridonic Stark, Vexica Lumaera, Vossloh Schwabe

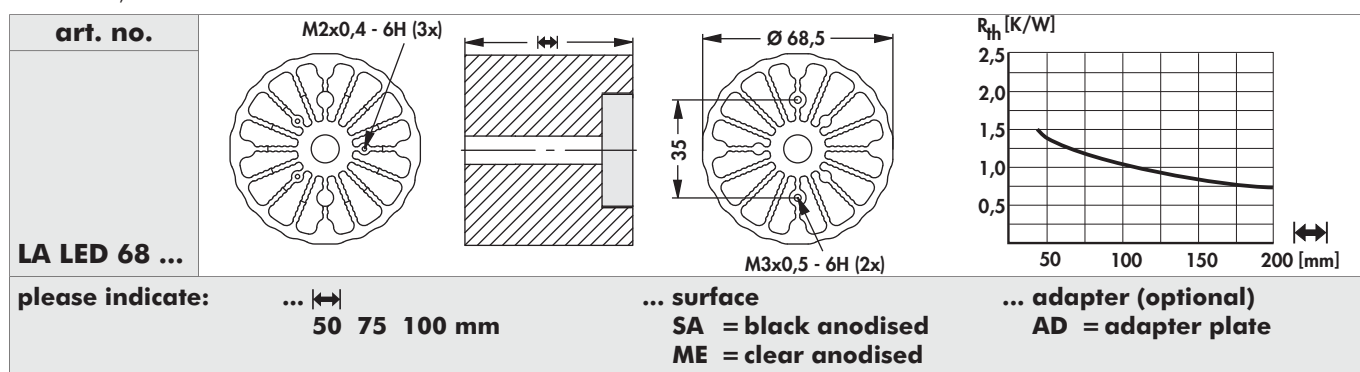

Technical data of the fans

	LF 40B12
circuit voltage	12 V
bearing type	two-way plain bearing
cur. consumpt.	50 mA
max. iinitial current	160 mA
max. volume flow	157 l/min - 9.4 m ³ /h
max. static pressure	3.4 mmH ₂ O - 33 Pa
noise level	26 dB(A), 1 m lateral
temperature range	-20°C... +60°C
failure rate (L₁₀)	60,000 h
MTBF	1,900,000 h (20°C)
Type rotor speed	6,600 min ⁻¹
weight	10 g

Sample box LED Heatsinks

- Sample box for verification of the thermal management for LEDs
- Contains a choice of different extruded heatsinks, LED extruded heatsinks in round design, LED pin heatsinks and extruded profiles for LED-Line modules
- for thermal contacting or mounting of LED a high-performance thermal conductive graphite foil is also enclosed (**WLFG**, sample strips 25x150mm), a high-performance thermal conductive (silicone-free) ceramic-filled thermal conductive paste (**WLPK**, syringe), a double-sided sticky thermal conductive foil (**WLFT 404**, sample strips 25x150mm) and a thermal conductive epoxy based two-component adhesive (**WLK DK**, syringe)

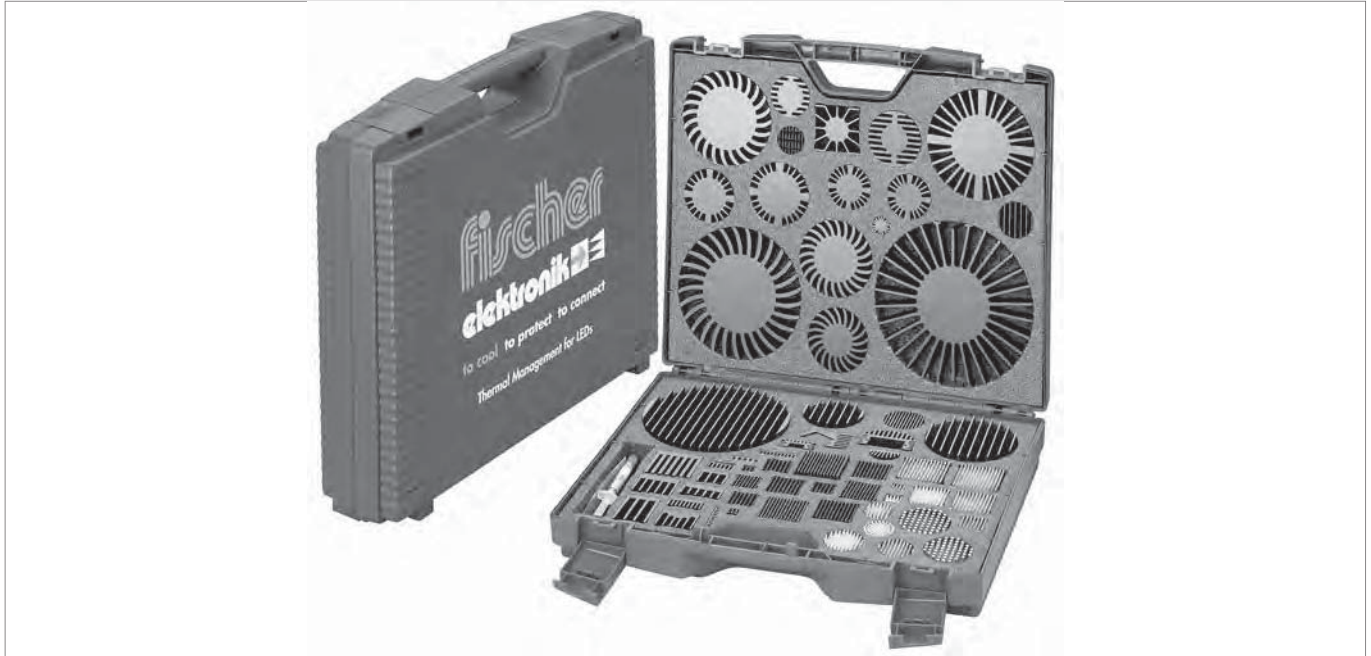

art. no.
SK LED BOX 1

B 51

Pin heatsinks Ø
Hole pattern
Special heatsink design
Thermal conductive paste

→ **B 29 – 33**
→ **A 21**
→ **A 137 – 138**
→ **E 21 – 22**

Mounts
Thermally conductive foil
Processor overview
Technical introduction

→ **E 44 – 48**
→ **E 5 – 15**
→ **B 2 – 10**
→ **A 2 – 8**